

Installer's Reference

UC-12-400-R0-012620











Adjustable Jump

Know What's Below

As with all projects involving digging, start by knowing what is in the ground below. Underground utilities may include cable, electric, sprinklers, sewer, water, telecommunications, drainage pipes and sprinklers. You can usually accomplish this with one phone call (Dial 811) to your state's underground utility service.

Conduct an Inventory

Begin installation with of hardware and parts, assuring everything you need is onsite when you begin.

ITEM	NO.	ITEMS NAME	PICT	COLOR	QTYS	PKGS	SET
 <p>(Assembled Unit)</p>	1	Verticle Post		Blue OR Green	2	PCS	3
	2	Adjustable Brackets/ Jump Bar		Blue OR Green	3	PCS	
	3	PE Bones		Tan	2	PCS	
HARDWARE	1	 TAMPER PROOF TORX-BOLT M10x30			4	PCS	1
	2	 FLAT WASHER M10			8	PCS	
	3	 LOCK NUT M10			4	PCS	
	4	 TAMPER TORX-BOLT M8x35			6	PCS	
	5	 LOCK WASHER M8			6	PCS	
	6	 FLAT WASHER M8			6	PCS	

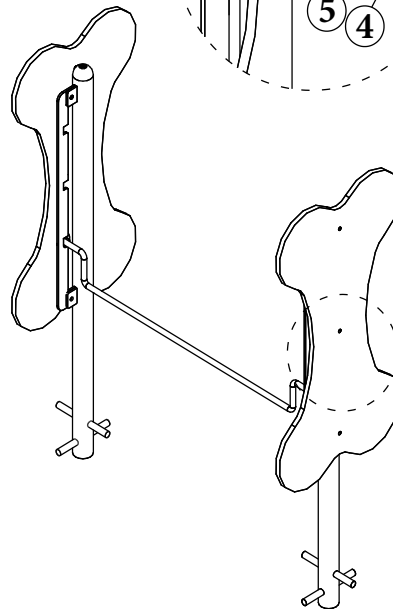
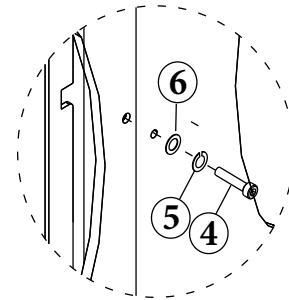
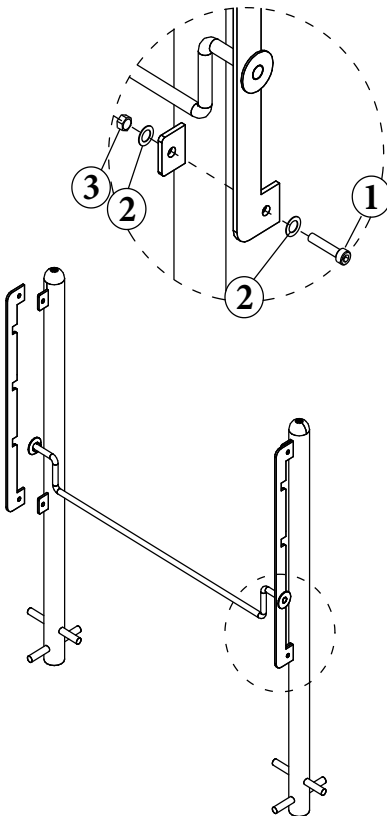
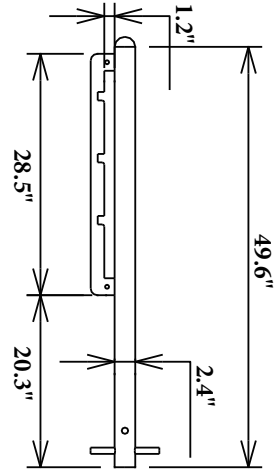
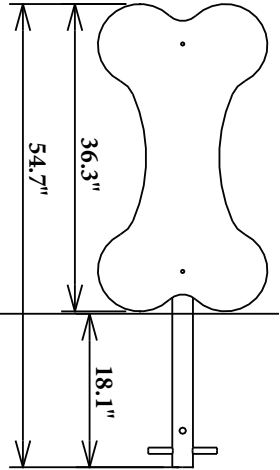
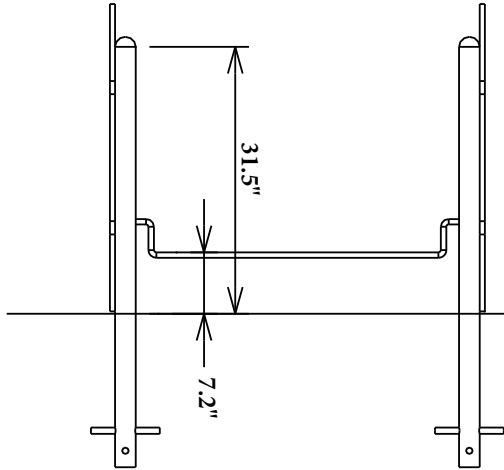
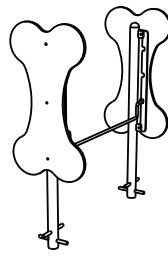
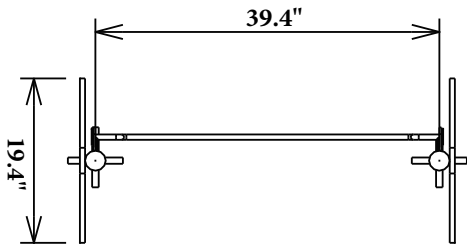

JUMP ASSEMBLY

- 1. TAMPER RESISTANT TORX-BOLT, M10x30 (4)
- 2. FLAT WASHER, M10 (8)
- 3. LOCK NUT, M10 (4)

BONE FACING

- 4. TAMPER RESISTANT TORX-BOLT, M8x35 (6)
- 5. LOCK WASHER, M8 (6)
- 6. FLAT WASHER, M8 (6)