

FBGP-620 / FBGP-620C

5 ft Offset Steel Football Goal Post for Semi-Permanent and Permanent Installation

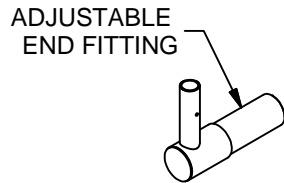

DETAIL A

HIGH SCHOOL:
FBGP-620 (WHITE)
FBGP-620YW (YELLOW)

COLLEGE:
FBGP-620C (WHITE)
FBGP-620CYW (YELLOW)

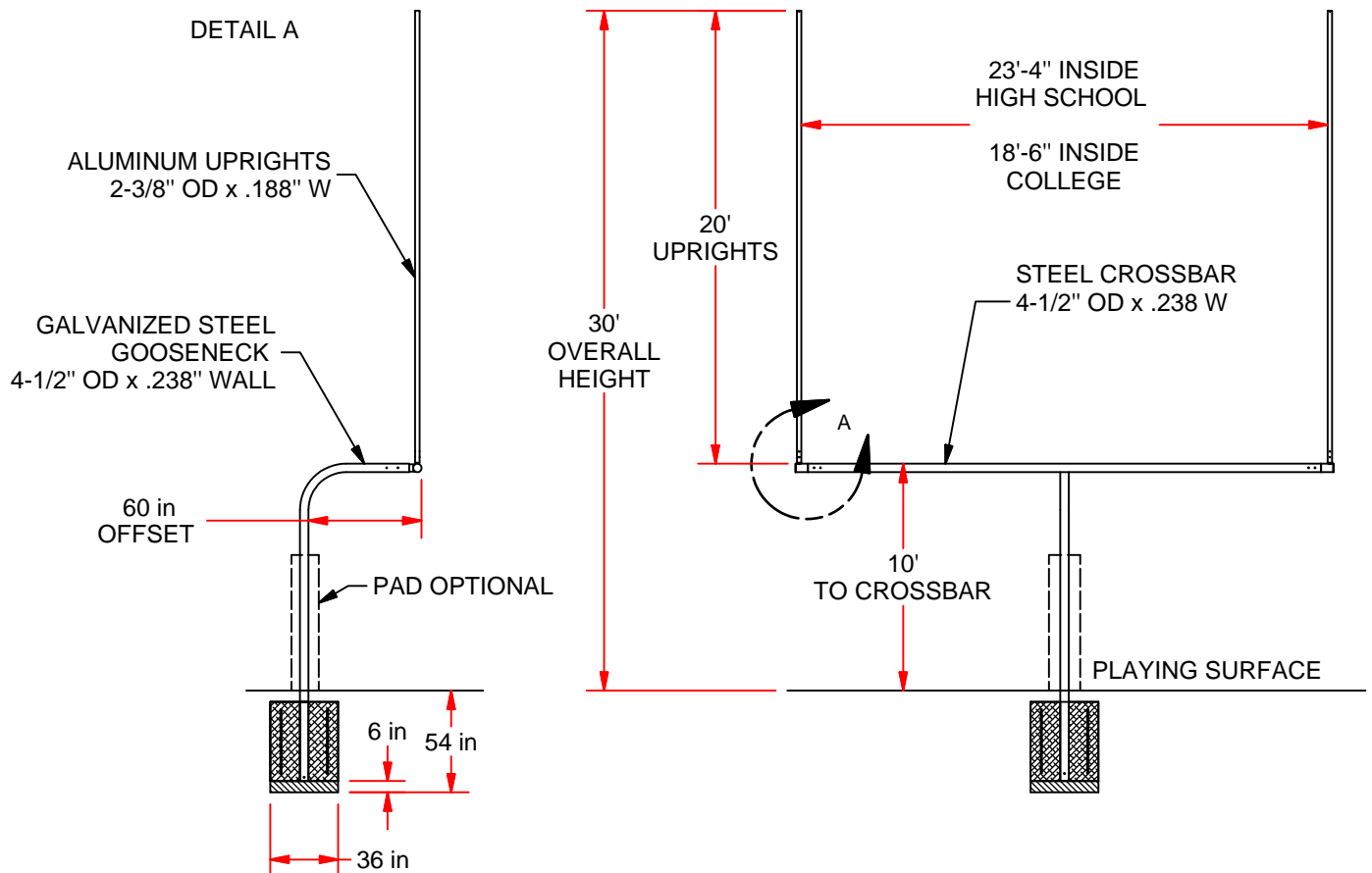

INSTALLATION OPTIONS:

- PERMANENT (SHOWN)
- SEMI-PERMANENT GROUND SLEEVE (FBSLV5)
- SEMI-PERMANENT GROUND SLEEVE WITH HEIGHT ADJUSTER (FBGPGS-5)

FEATURES:

- MEETS NFHS AND NCAA REGULATIONS
- ALLOWS FOR PRECISE LEVELING OF CROSSBAR AND PLUMBING OF UPRIGHTS
- ZINC PRIMED WITH STANDARD YELLOW OR WHITE POWDER COATED FINISH

OPTIONAL ACCESSORIES:

- NEON YELLOW (PNT-1NY)
- SAFETY PADDING (PPP-500)
- WIND STREAMERS (WS-42)
- ACCESS FRAME (FBGPAF-1)
- SOCCER GOAL ANCHOR KIT (SFGA-4)

NOT TO BE USED FOR INSTALLATION