

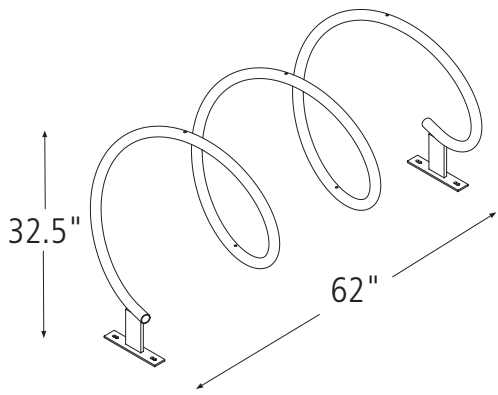

HELIX RACK

Specifications and Space Use



Capacity 6 Bikes

Materials 1.25" Pipe (1.66" OD)



Finishes



A hot dipped galvanized finish after fabrication is standard. Powder coat, thermoplastic, and stainless steel options are also available.

Installation Methods



Recommended Install Base Materials

Solid concrete is the best base material for installation. Ask your Dero Rack representative which anchor is appropriate for your application to ensure the proper anchors are shipped with your rack. Be sure nothing is underneath the base material that could be damaged by drilling.

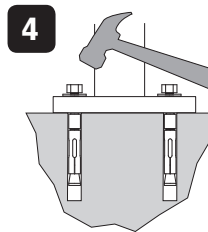
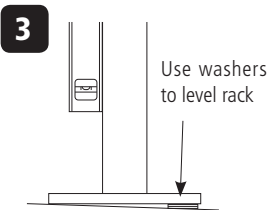
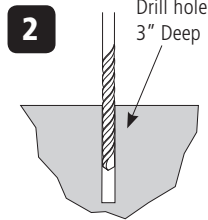
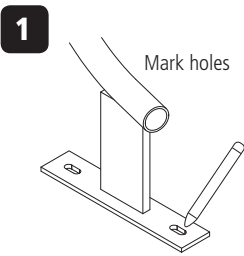

(Anchors will vary according to install surface)

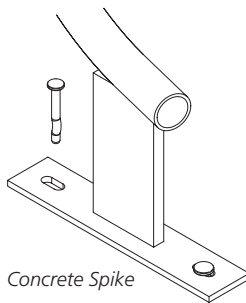

Concrete Spike

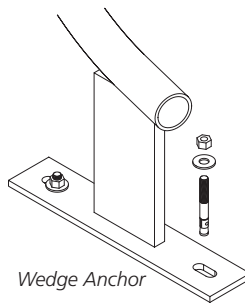

Wedge Anchor

Installation

3/8" anchors are shipped with the rack. Place the rack in the desired location. Use a marker or pencil to outline the holes of the flange onto the base material. Drill the holes in accordance with the specifications shipped with the anchors. Make sure the holes are at least 3" away from any cracks in the base material. Tap in anchors and follow directions for the specific anchor shipped with the rack.

In Ground Mount

An in ground mounting option is available by special order.

Space Use and Setbacks



Wall Setbacks: A minimum of 74" should be left between the wall and the long side of the rack. If placing the Helix perpendicular to the wall 12"-24" is the recommended setback.

Distance Between Racks: Helix ends can be placed together to look like a continuous spiral. Helixes placed parallel with each other should allow for 13' between each rack, measured center to center.

Street Setbacks: 74" is the minimum setback distance between the street and the rack. 77" is recommended.

